



X-Tray[®] X-Rack

Telecom & Data





Made in Sweden. Works global.

Axellent Group has grown into an international group with a total workforce of over 200 persons. Our products are sold in 50 countries and our vision is to continue to expand.



Axellent Team X-Tray develops, manufactures and markets a complete cable routing system based on wire trays under the brand name of X-Tray. We have created a premium brand with regard to ultimate design, functionality, materials and service. Customer collaboration is another key aspect. We appreciate customers with high demands because it enables us to continue developing tailored solutions. Our close proximity to our design and production teams and, not least, a passion for innovative and smart solutions, means we can quickly move from concept to finished product.

Our products are sold all over the world and are mostly found in the energy, infrastructure, food, machinery, off shore and telecom & data industries.

Premium brands for your safety

There is an ever-growing need for telecom and data solutions. Axellent's X-Rack (installation), X-Tray (cable routing system) and X-Guard (partitions and safety) ranges offer complete solutions for these sectors.

Efficient production processes

Axellent's head office is in Hillerstorp, Sweden. All product development, production, storage and packaging is carried out here. Our production is highly automated to manage high volumes and speedy deliveries.

As all our standard products are in stock, we can usually ship your order the same day as we get it.

A safe choice

Axellent has unparalleled knowledge and experience of safety solutions for industry, storage and construction. Please consult us for the ultimate safe and secure environment.

Instant quote

We will give you a quote, a drawing and deliver on the same day. If you are looking for a special solution we will tailor the product to your needs.



X-Rack takes you that extra mile.

X-Rack is a complete solution. The system organises, facilitates and protects equipment in all types of environments.

- ❶ Axelent's X-Rack and X-Tray systems are ideal for installing in technical shelters.
- ❷ An X-Rack installation in a technical shelter.
- ❸ The flexible X-Rack system offers a range of possibilities.
- ❹ Cable ducts mounted on X-Rack give neat and efficient cable runs.
- ❺ Complete installation in a server room with Axelent X-Tray.



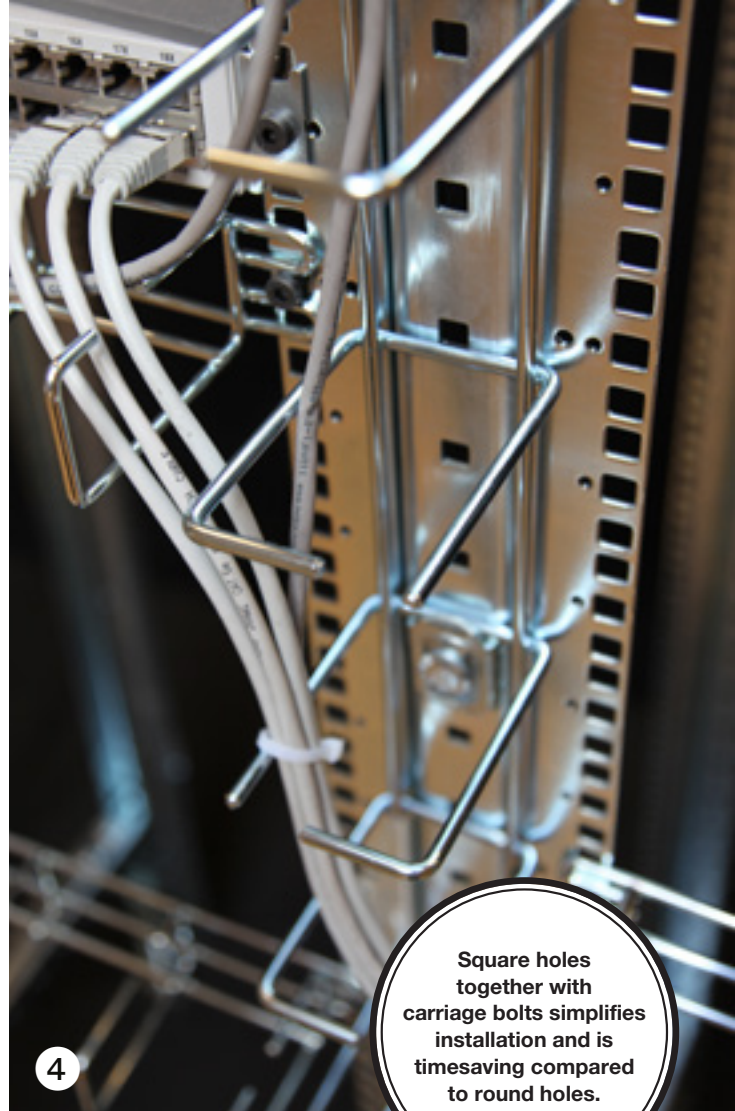

Square holes together with carriage bolts simplifies installation and is timesaving compared to round holes.

X-Rack – one of the strongest and most flexible open rack systems on the market.

With the help of Axellent's U-Bars and a few accessories you can build a data rack tailored to your needs. You can design it for the equipment to be fixed on the front edge, the middle or both front and back edge. The depth and height of the rack is determined by the length of the U-Bars. X-Rack comes in several standard sizes, but can also be cut or ordered to the required size.

All the parts are ordered separately, making it easier to adapt to your needs and quick and easy to transport and assemble in just a few minutes. Preassembled

racks are also available on request. Customer-specific product kits can also be made to simplify future ordering and installation.

One advantage with this is that the wire trays can be fitted directly on X-Rack without the need for brackets and pendants.

We also have accessories like radius limiters and cable trays that allow cables to be installed neatly, safely and easily.



X-Rack – far superior than any IT cabinet. Here are the reasons.

Add to it, remove things, customise.

- ✓ Lower cost price
- ✓ Better accessibility
- ✓ Easier to cool
- ✓ Lower maintenance costs
- ✓ Variable height and depth
- ✓ Requires less space
- ✓ Easier to transport
- ✓ Easier to modify
- ✓ Cable runs can be integrated with X-Rack and installed in several easy ways

Examples of X-Rack kits

Unassembled rack with cable duct, Fzb:

Small cable duct

2000x600 mm Item No. 7100-200
2200x600 mm Item No. 7100-201

Large cable duct

2000x600 mm Item No. 7100-204
2200x600 mm Item No. 7100-205

Battery rack with cable duct Fzb:

Small cable duct

2000x600 mm Item No. 7100-202

Large cable duct

2000x600 mm Item No. 7100-206

We will supply preassembled rack sides on request.

Preassembled rack sides, Fzb:

2000x600 mm Item No. 7100-210
2200x600 mm Item No. 7100-211

Why not customise your own kit? Ask us how.

ASSEMBLY INSTRUCTIONS

X-Rack

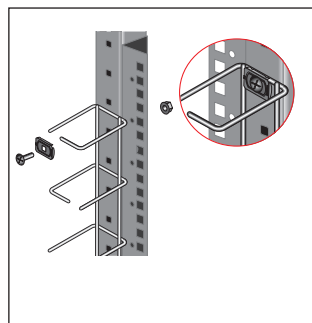
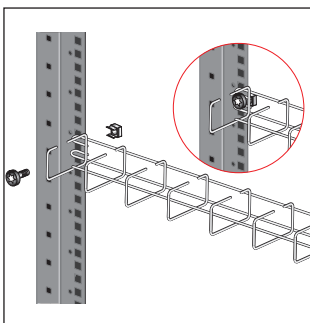
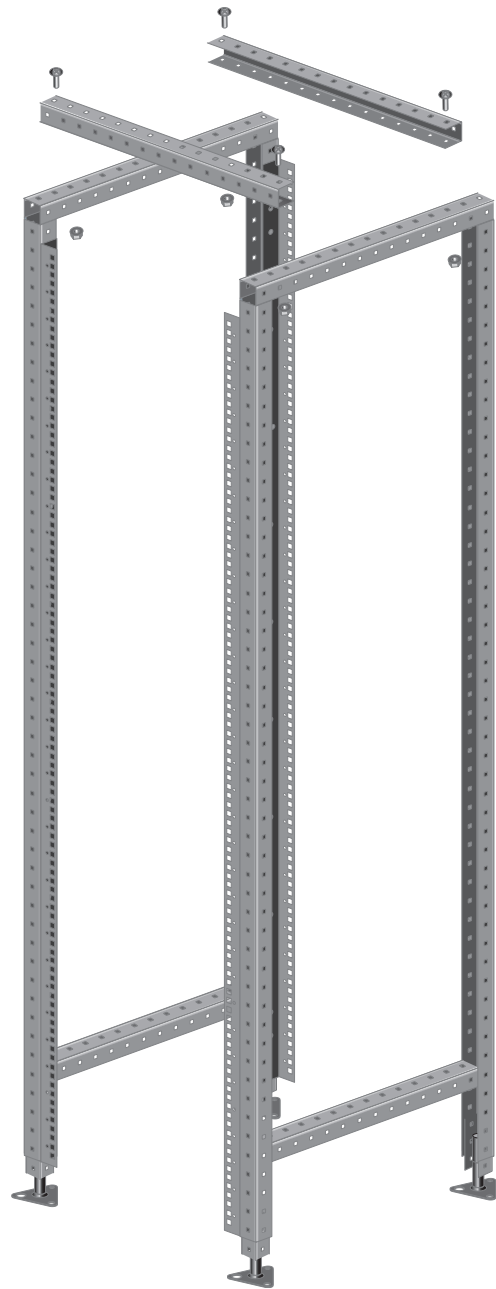
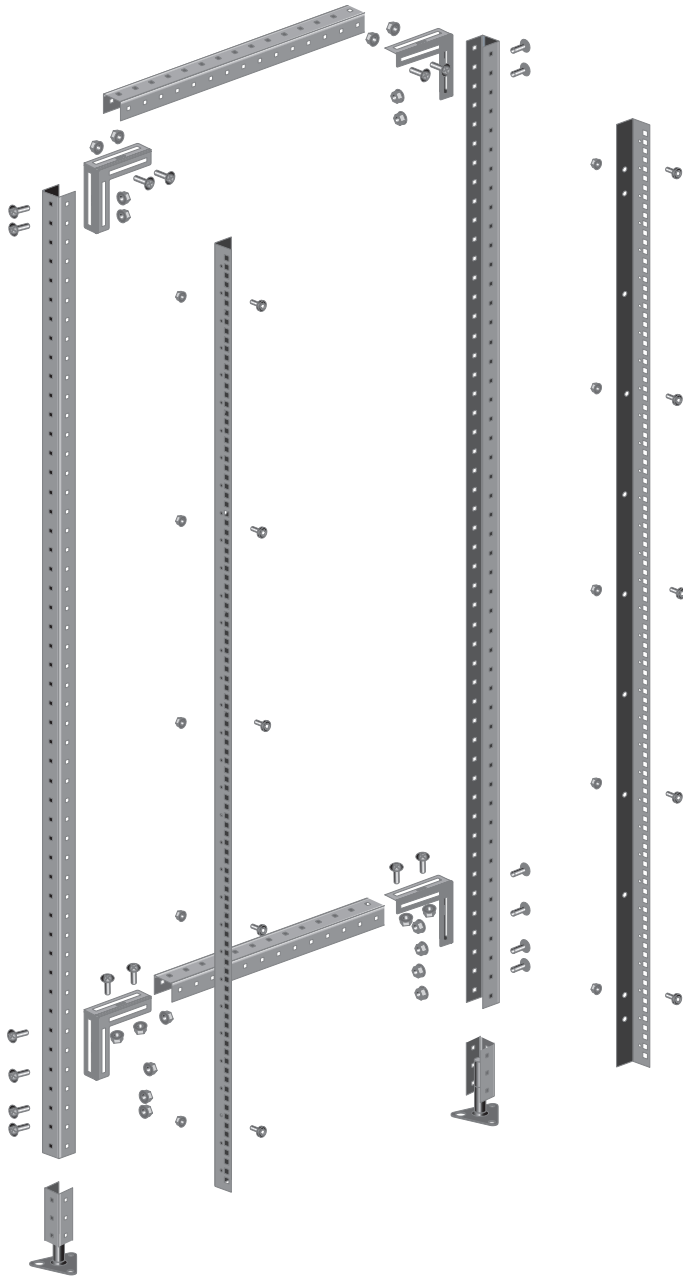

Contact us
for more
information.

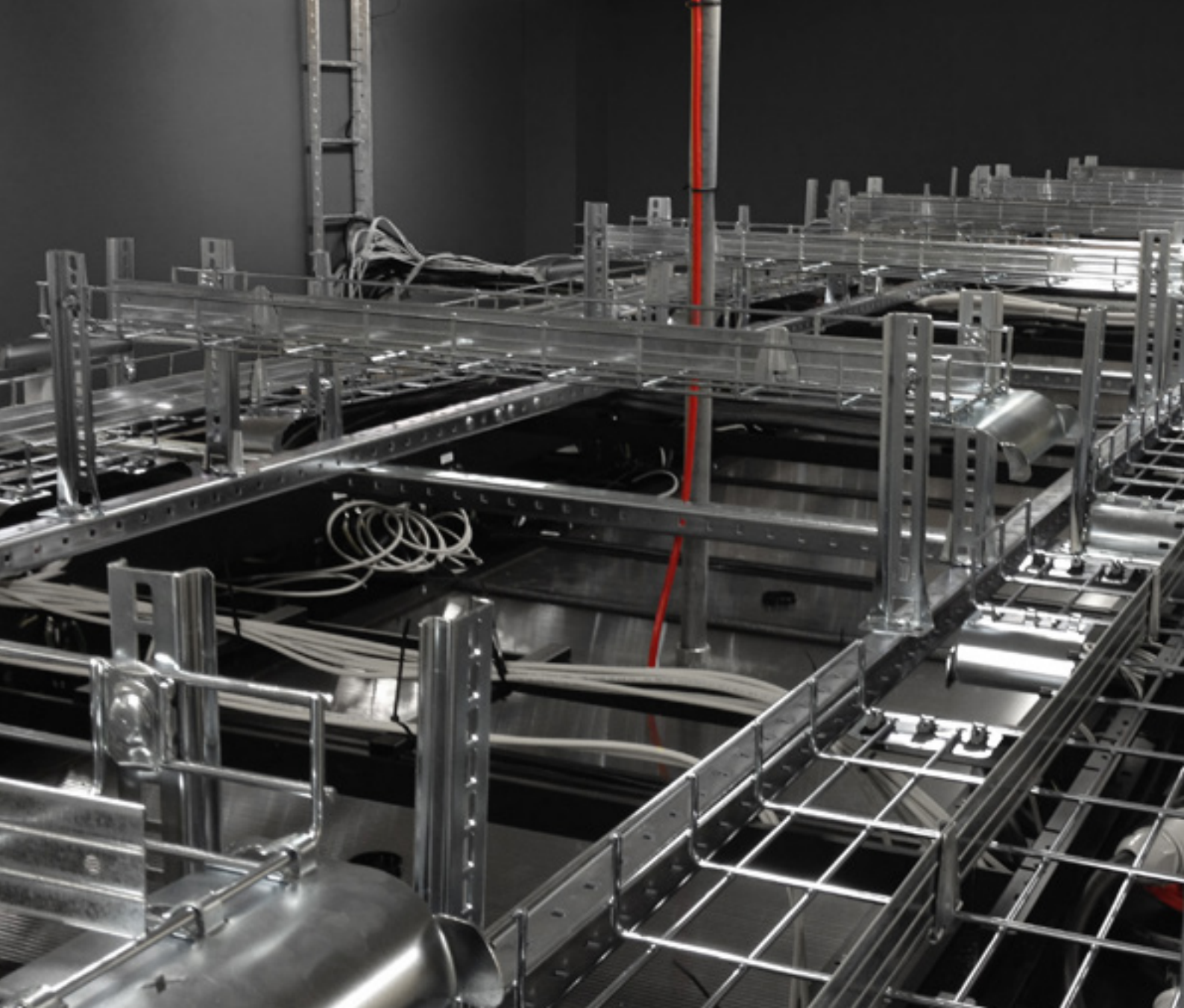

X-Tray – from small technical shelters to large server rooms.

Axelent has the products that function in all types of telecom and data installations. We help you from project start to final installation. This includes everything from drawings, tailored products and special kit with solutions to match your needs (such as cut wire trays and tailored

lengths). We also offer preassembly of certain products to further simplify onsite installation. For extra safety and protection, we offer turnkey solutions with X-Guard (see page 14).



X-Tray has the longest support distance on the market!



X-TRAY®



*Our UL certification also gives us NEMA APPROVAL.



X-Tray complies with the highest demands on cable routing systems as laid down in IEC 61537.

Contact us for more information. We help you to find the right solution.



Example of a tailored product kit

X61 Carriage Bolt M8
25 pcs

X62 Flange Nut M8
25 pcs

X1 Fitting
16 pcs

X3 Angled Fitting
7 pcs

X5 Joining Fitting
4 pcs

X14 Pendant 280
6 pcs

X17 Support Hook
6 pcs

X10 Mini Bracket
3 pcs

X15 Bracket
2 pcs

X-Tray 120x60x2500
1 pc

X-Tray 120x60x1200
2 pcs

X-Tray 120x60x2300
1 pc

X-Tray 220x60x1800
1 pc

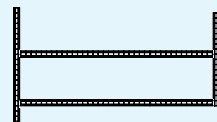
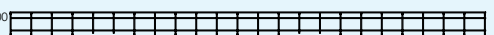
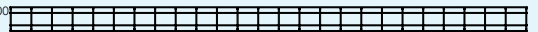

X-RACK

The accessories are design protected.
Subject to change without prior notice.

X50 U-Bar	Length	Item No.
Zinc-Plated Fzb	400	2150-400
Zinc-Plated Fzb	520	2150-520
Zinc-Plated Fzb	600	2150-600
Zinc-Plated Fzb	720	2150-720
Zinc-Plated Fzb	800	2150-800
Zinc-Plated Fzb	920	2150-920
Zinc-Plated Fzb	1000	2150-1000
Zinc-Plated Fzb	1920	2150-1920
Zinc-Plated Fzb	2120	2150-2120
Zinc-Plated Fzb	2480	2150-2480
Zinc-Plated Fzb	3000	2150-3000

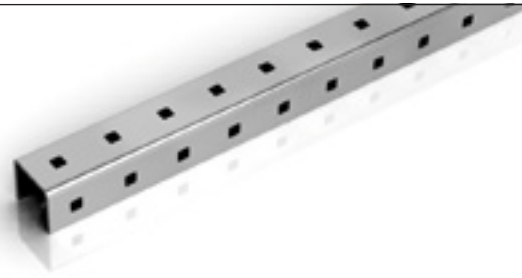

X51 U-Bar Joining Fitting		
Zinc-Plated Fzb	2151	



X52 U-Bar Corner Fitting		
Zinc-Plated Fzb	2152	



X53 U-Bar Adjustable Foot		
Zinc-Plated Fzb	2153	



X54 U-Bar End Cap		
Black Plastic	2554	



X55 U-Bar Angled Fitting		
Zinc-Plated Fzb	2155	



X60 Radius Limiter		
Zinc-Plated Fzb	120	2160-120
	220	2160-220
	320	2160-320
	420	2160-420



Bending Plate		
Aluminum	120	7500-021
	220	7500-022
	320	7500-023
	420	7500-024



X69 Side Radius Limiter		
Zinc-Plated Fzb	106	2169-100
	206	2169-200



Mounting Profile 1876-42U incl. brackets		
Zinc-Plated Fzb	1876	7100-050
Mounting Profile 2060-46U incl. brackets		
Zinc-Plated Fzb	2060	7100-051
Mounting Profile 2238-50U incl. brackets		
Zinc-Plated Fzb	2238	7100-058



Mounting Profile ETSI incl. brackets		
Zinc-Plated Fzb	1876	7100-078
Mounting Profile ETSI incl. brackets		
Zinc-Plated Fzb	2060	7100-079
Adapter ETSI to 19"		
Zinc-Plated Fzb	936	7100-080

Cable Duct incl. brackets		
Small		
Zinc-Plated Fzb	95x65x800	7100-052
Large		
Zinc-Plated Fzb	120x80x800	7100-250



Cable Duct 19" Horizontal incl. brackets		
Zinc-Plated Fzb	7100-054	



X-Rack Floor plate		
Zinc-Plated Fzb	312x560	7100-220
Black Galvanized	312x560	7700-220



Wall Bracket Sandwich Panel		
Zinc-Plated Fzb	330	7100-088
	660	7100-089



X-Rack Shelf		
Zinc-Plated Fzb	600x560	7100-221
Black Galvanized	600x560	7700-221



Cage Nut M6		
Zinc-Plated Fzb	7100-055	



Torx Screw M6x12		
Zinc-Plated Fzb	7100-057	



X61 Carriage Bolt M8x27 (40 pcs)		
Zinc-Plated Fzb	2161	



Flange nut M6		
Zinc-Plated Fzb	7100-056	









X62 Flange Nut M8 (40 pcs)		
Zinc-Plated Fzb	2162	



The accessories are design protected.
Subject to change without prior notice.

X-TRAY®

U	U	C	G	Mini
				
Height 60 mm Length 2500 mm Item No.	Height 110 mm Length 2500 mm Item No.	Length 2500 mm Item No.	Length 2500 mm Item No.	Length 2500 mm Item No.
X-Tray 53x46x2500 Zinc-Plated Fzb 0199-053	X-Tray 120x110x2500 Zinc-Plated Fzb 0112	X-Tray C70x68x2500 Zinc-Plated Fzb 1110	X-Tray G60x100x2500 Zinc-Plated Fzb 1121	X-Tray Mini 30x22x2500 Zinc-Plated Fzb 1152
X-Tray 60x60x2500 Zinc-Plated Fzb 0101	X-Tray 220x110x2500 Zinc-Plated Fzb 0122	X-Tray C120x80x2500 Zinc-Plated Fzb 1111	X-Tray G120x150x2500 Zinc-Plated Fzb 1122	X-Tray Mini 40x22x2500 Zinc-Plated Fzb 1153
X-Tray 75x60x4x2500 Zinc-Plated Fzb 0199-0754	X-Tray 320x110x2500 Zinc-Plated Fzb 0132	X-Tray C220x120x2500 Zinc-Plated Fzb 1112	Plan	X-Tray Mini 40x32x2500 Zinc-Plated Fzb 1154
X-Tray 75x60x5x2500 Zinc-Plated Fzb 0199-0755	X-Tray 420x110x2500 Zinc-Plated Fzb 0142			X-Tray Mini Accessories Self drilling screw Zinc-Plated Fzb 7100-070
X-Tray 120x60x2500 Zinc-Plated Fzb 0111	X-Tray 520x110x2500 Zinc-Plated Fzb 0152		Length 2500 mm	
X-Tray 220x60x2500 Zinc-Plated Fzb 0121	X-Tray 620x110x2500 Zinc-Plated Fzb 0162		Item No.	
X-Tray 320x60x2500 Zinc-Plated Fzb 0131			X-Tray Plan 161x4x2500 Zinc-Plated Fzb 4199-010	
X-Tray 420x60x2500 Zinc-Plated Fzb 0141				
X-Tray 520x60x2500 Zinc-Plated Fzb 0151				
X-Tray 620x60x2500 Zinc-Plated Fzb 0161				

Psst...

You will find the complete range, more technical specs and designs, such as colours and surface treatments, at www.axelent.com and in the **“Technical Manual”**.

Many of the items are available in a black finish.

Go to axelent.se or give us a call on **+46 370-37 37 30**. We are at your service.

ACCESSORIES

The accessories are design protected.
Subject to change without prior notice.

Fittings



X1 Fitting
Zinc-Plated Fzb

Item No.
2101



X2 Fitting
Zinc-Plated Fzb

Item No.
2102



X3 Angled Fitting
Zinc-Plated Fzb

Item No.
2103



X4 Fitting
Zinc-Plated Fzb

Item No.
2104



X5 Joining Fitting
Zinc/Nickel
20 pcs

Item No.
2105



X61 Bolt M8x27
Zinc-Plated Fzb
40 pcs

Item No.
2161

X62 Flange Nut M8
Zinc-Plated Fzb, 40 pcs

2162

Mounting



X10 Bracket
Zinc-Plated Fzb

Item No.
2110-1



X10 Mini Bracket
Zinc-Plated Fzb

Item No.
2110-2



X11 Pendant Heavy
Zinc-Plated Fzb

Item No.
2111-240 L = 240
2111-480 L = 480



X12 Flexible Pendant
Zinc-Plated Fzb

Item No.
2112-240 L = 240
2112-480 L = 480



X13 Side Support, L = 1000
Zinc-Plated Fzb

Item No.
2113



X14 Pendant
Zinc-Plated Fzb

Item No.
2114-100 L = 100
2114-280 L = 280
2114-460 L = 460

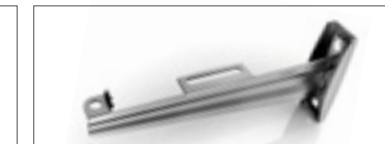

X15 Bracket
Zinc-Plated Fzb

Item No.
2115-12 W = 120
2115-220 W = 220
2115-320 W = 320
2115-420 W = 420
2115-520 W = 520
2115-620 W = 620



X16 Floor Support
Zinc-Plated Fzb

Item No.
2116



X17 Support Hook 120-320
Zinc-Plated Fzb

Item No.
2117



X18 Support Hook 420-620
Zinc-Plated Fzb

Item No.
2118

Threaded Rod

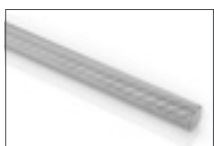

X30 Threaded Rod M8, L = 1000
Zinc-Plated Fzb

Item No.
2130



X31 TR Support Hook,
Zinc-Plated Fzb

Item No.
2131



X33 TR Adapter
Zinc-Plated Fzb

Item No.
2133



X34 Ceiling Fitting
Sendzimir

Item No.
2234



X35 TR Distance Nut
Zinc-Plated Fzb
10 pcs

Item No.
2135



X36 TR Beam Clamp
Zinc/Nickel

Item No.
2236

The accessories are design protected.
Subject to change without prior notice.

ACCESSORIES

Accessories



X63 Accessories Holder
Zinc-Plated Fzb

Item No.
2163-1 With holes

2163-2 Without holes



X80 Side Accessories Holder
Zinc-Plated Fzb

Item No.
2180-1 With holes

2180-2 Without holes



X64 L-Divider
Sendzimir
L = 2500

Item No.
2264-45 W = 45

2264-95 W = 95



X65 Tray Cover
Sendzimir
L = 1000

Item No.
2265-60 W = 60

2265-75 W = 75

2265-120 W = 120

2265-220 W = 220

2265-320 W = 320

2265-420 W = 420

2265-520 W = 520

2265-620 W = 620



X66 Divider
Sendzimir
L = 2500

Item No.
2266-45 H = 45

2266-95 H = 95



X67 Divider Clamp
Sendzimir

Item No.
2267



X68 Equipotential Bonding
Screw A
Brass

Item No.
2568



X68 Equipotential Bonding
Screw B
Brass

Item No.
2568-1



X70 Marking Clip

Item No.
2570-01 Neutral

2570-03 Eq. Bond



X72 Safety Cap
15,6 mm, Ø 4-6 mm
Plastic, 100 pcs

Item No.
2572-4 4 mm

2572-5 5 mm

2572-6 6 mm

Tools



X75 Bolt Cutter

Item No.
2575



X76 13 mm Spanner

Item No.
2576



X77 Cable Tray Cutter
Battery Powered

Item No.
2577

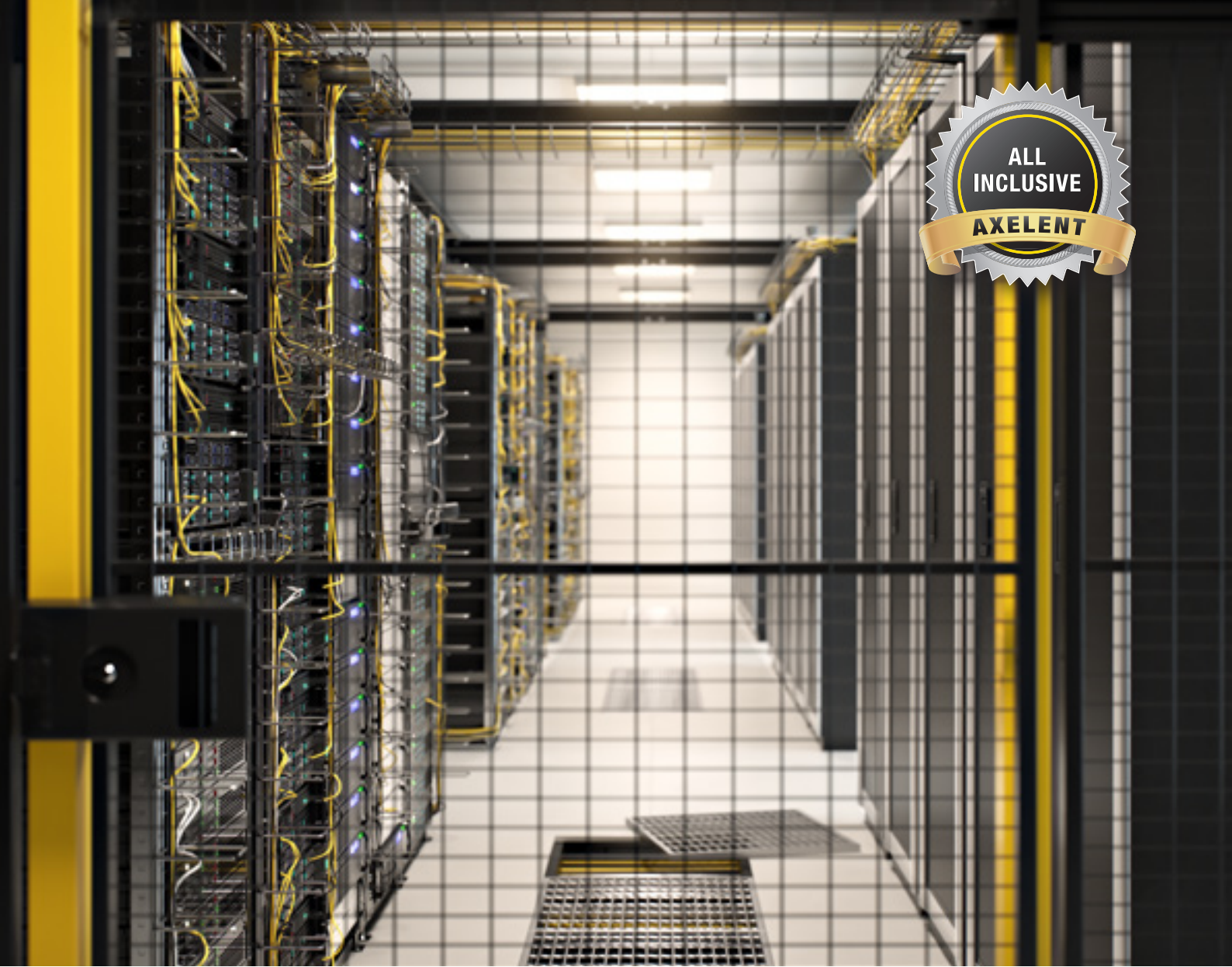

X-Guard helps you to protect your valuable equipment.

Axelent's X-Guard is a complete machine guard series that complies with the Machine Directive's (2006/42/EC) requirement for permanent protection.

With its wide range of standard components and accessories, X-Guard is guaranteed to cover all your machine guard needs.

X-Tray wire trays integrate easily with Axelent's X-Guard machine guards. All the wire trays for X-Guard are black galvanized to give a stylish and integrated look. The product is durable and quick and easy to install, and, like X-Guard, only needs a few tools and fittings.

Easy to combine for optimum safety

X-Guard machine guards are easy to combine with X-Tray wire trays and give a neat and secure installation.

No special tools are required

The combination is easy to assemble without the need for any special tools.

One supplier

Complete solutions from the same supplier makes it quick and easy to complete your project.

Find out more at www.axelent.com



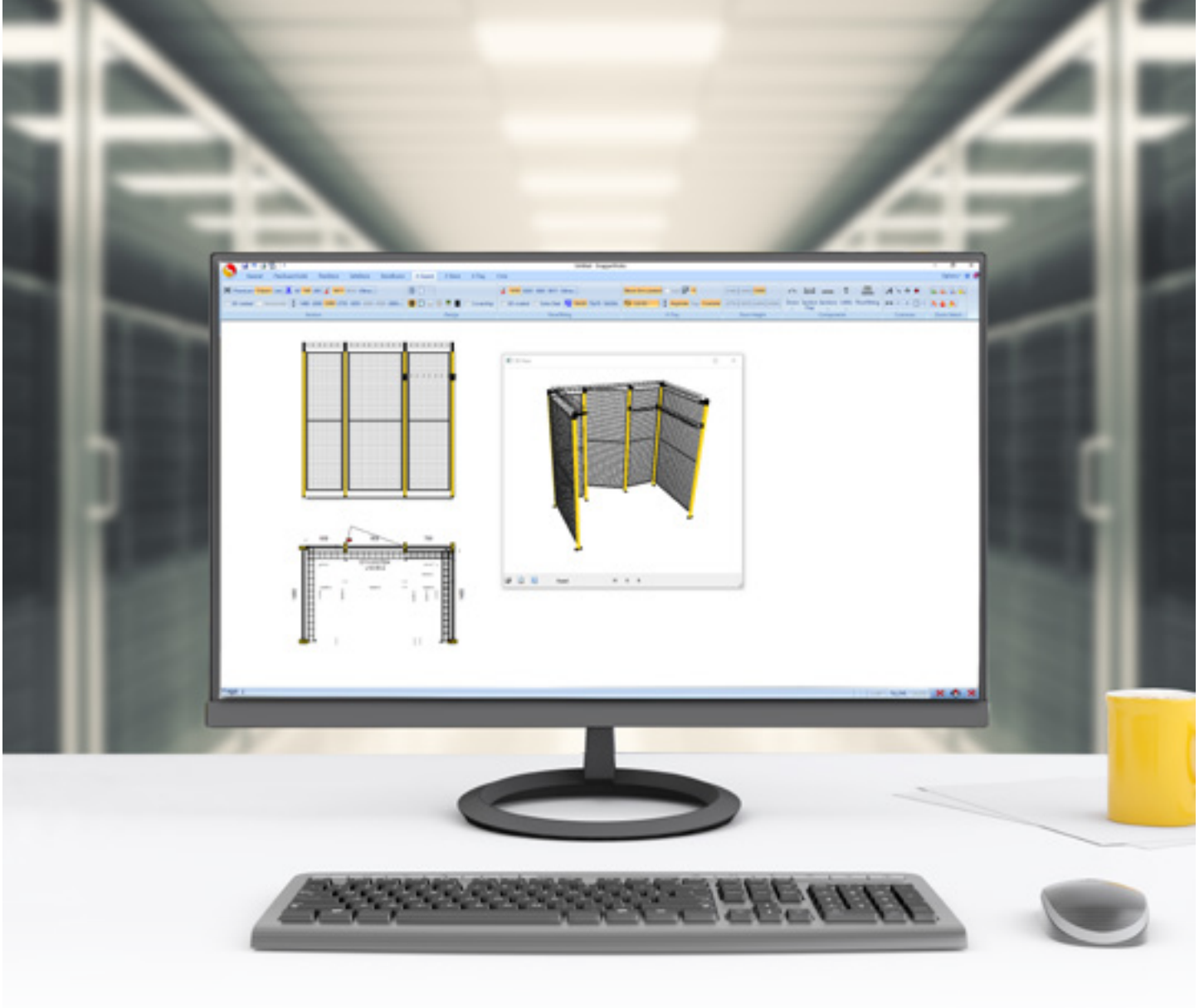

Axellent, a turnkey concept.

Axellent offers more than just wire trays and mesh panels. Our concept is built around a turnkey solution of more than one product. We do our utmost to give our customers the best possible service.

We always strive to live up to your expectations with regard to products and services. Our motto is Axellent Quality – Service, Safety, Speed, Spirit, Know-how.

SnapperWorks CAD program

Axellent's inhouse developed, user-friendly CAD program, SnapperWorks, is tailored to Axellent's modules and contains all our systems for mesh walls, machine guards and wire trays (X-Tray for X-Guard). You can import DWG and DXF files and you can draw walls straight on to the drawing.

We guarantee and deliver!

- ✓ We answer when you call
- ✓ We stock standard products.
- ✓ Speedy deliveries



AXELENT

AXELENT · AXELENT ENGINEERING · AXELENT SOFTWARE

AXELENT AB · BOX 1 · KÄVSJÖVÄGEN 17 · SE-335 04 HILLERSTORP, SWEDEN
+46 (0)370 37 37 30 · SALES@AXELENT.SE · WWW.AXELENT.SE