



Axelent **X-Store 2.0**

Secure, smart mesh panels for industrial and warehouse applications

Version
1.0
English





AXELEN'T



Made in Sweden. Works global.

The Axelent Group has grown into an international group of companies with a total workforce of over 300 people. Our products are sold in 60 countries and our vision is to keep on expanding.



Axelent is a Swedish company with extensive experience within the manufacture of mesh wall systems in the form of protection and partitioning systems for industry, warehouses and construction. Speed, safety, service and smart solutions are watchwords that characterise our entire organisation and business. We are market leaders within several sectors and our products are represented all over the world.

Smart and secure system

Partition or enclose. Create new, change or extend. Needs differ from one industry or warehouse to another. Just like our other products, we have developed X-Store based on the criteria that it should be easy to assemble and supplement, and function in most types of environment. If you choose Axelent X-Store you can feel rest assured because this warehouse and industry system has numerous combinations and applications. You also get a flexible, safe and economic system into the bargain.

Effective production

Our head office is in Hillerstorp, Sweden. All product development, production, warehousing and packaging also takes place here. Much of our production is automated in order to cope with high volumes and fast delivery times. As all our standard products are in stock we can deliver your order within 5-7 working days.

Quotation and drawing straight away

Our own SnapperWorks drawing application enables us to quickly provide you with a quotation including a drawing and material specification.

A safe choice

Axelent has extensive, in-depth knowledge when it comes to safety for industry, warehouses and construction work. Please consult us in order to get a safe and secure environment as possible using our products.

X-Store second generation secures your warehouse

The X-Store system is designed to give you easy and secure access to your warehouse. The second generation offers a number of benefits and improvements. This includes a dedicated ceiling solution, easy independent removal of adjacent panels and a single post that can be used in three different directions - including corners!

Benefits of X-Store 2.0

- ✓ **New fast and unique way to attach panels** to posts
- ✓ **Wide range of locks and doors** (based on the same system that is used for X-Guard)
- ✓ **Remove a panel without affecting** the adjacent panels
- ✓ **Build right up to the ceiling**
- ✓ Available in **SnapperWorks**
- ✓ **Modular concept** – custom height and width
- ✓ New **floor fitting design** – combine with posts of standard height for **cost efficiency**
- ✓ **Flexible posts** – build in 3 different directions, including corners
- ✓ **Easily adjust the height** of each panel individually
- ✓ **New joint** for easier and stronger vertical constructions
- ✓ **Clearly marked entrances and exits** with different wall and door panel colours
- ✓ **Made-to-measure installations** with cutting kits and adjustable panel inserts
- ✓ **Ceiling in unlimited length**, max. width 6 m

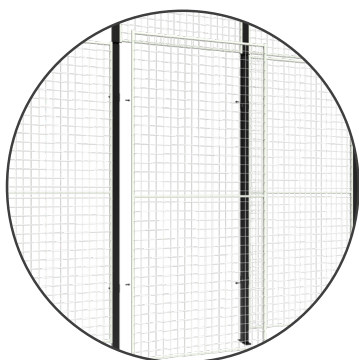

Smooth removal

Remove/move a panel without affecting the adjacent panels.

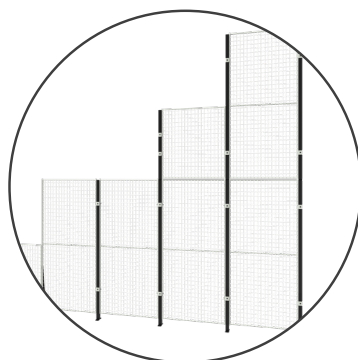

Modular concept

X-Store 2.0 grows with you – in both height and width.

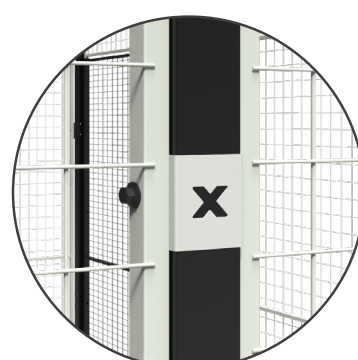

Unique attachment

Attach panels to posts quickly and with great results.



Draw your X-Store system in Axelent's drawing program SnapperWorks for free! Click and drag features. With 3D view. The drawing works as an order basis.

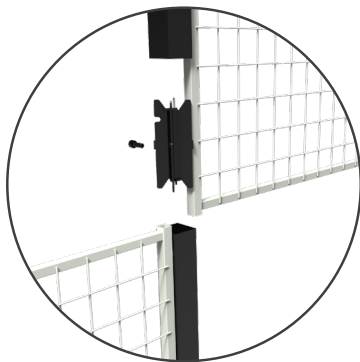

New strong joint

Building higher panel walls are easy.

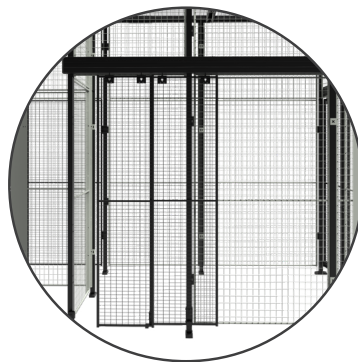

Marked passage

Show the way with colour. The door panel is black while the mesh walls are grey

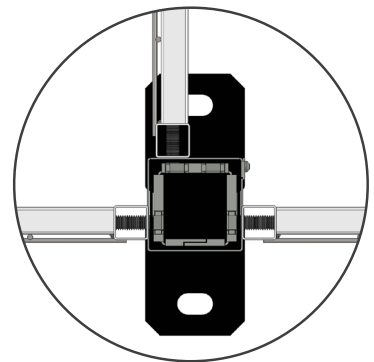

Flexible posts

Build in 3 different directions, including corners.



X-Store 2.0 – industry and warehouse system

Easily adaptable

The X-Store 2.0 sections are available in two heights and several widths. Using feet, posts and extensions you can tailor the panels to suit your needs. We offer a cutting service to ensure your panels are perfectly dimensioned, horizontally and vertically.

Combine with a door package

It is also possible to combine X-Store 2.0 with one of our door packages. If you want a special colour to fit in with the rest of your decor we can naturally fix that as well. Everything is delivered plastic-wrapped on our customised pallets straight from Hillerstorp.

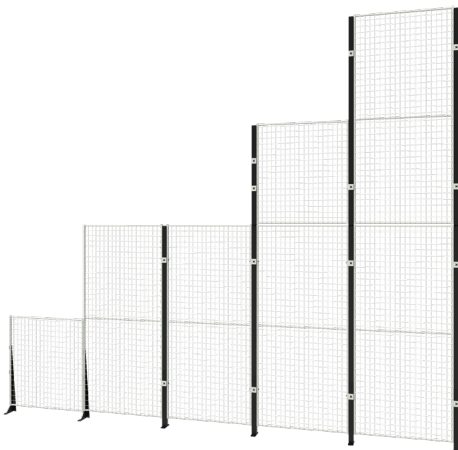

Product Facts X-Store 2.0

Vertical tubing	19x19 mm
Horizontal tubing	15x15 mm
Posts	50x50 mm, 70x70 mm or floor fitting
Vertical wires	Ø 3
Horizontal wires	Ø 2.5
Mesh aperture	50x60
Gap to floor distance*	100 mm
Coating	Phosphate/Epoxy paint
Colour, mesh panel	Grey RAL 9018
Colour, post	Black RAL 9011

(Other colours can be quoted)

** Coverstrip to close the gap is available as an option*

Product Facts » X-Store 2.0

Mesh panel (Height 2200 mm)

Art.no.	Height (mm)	Width (mm)
---------	-------------	------------

Light grey RAL 9018

413-220025	2200	0250
413-220040	2200	0400
413-220070	2200	0700
413-220100	2200	1000
413-220120	2200	1200
413-220150	2200	1500

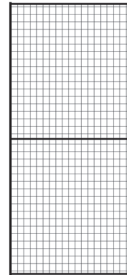

Mesh panel (Height 1100 mm)

Art.no.	Height (mm)	Width (mm)
---------	-------------	------------

Light Grey RAL 9018

413-110025	1100	0250
413-110040	1100	0400
413-110070	1100	0700
413-110100	1100	1000
413-110120	1100	1200
413-110150	1100	1500

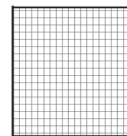

Posts

Art.no.	Gap to floor (mm)	Height (mm)
---------	-------------------	-------------

50x50 mm foot included, Black RAL 9011

P3101-230	100	2300
-----------	-----	------

70x70 mm foot included, Black RAL 9011

P3301-230	100	2300
-----------	-----	------

① Extension 50x50 mm, Black RAL 9011

E3101-110	1100
E3101-110B (above sliding door)	1100
E3101-220	2200
E3101-220B (above sliding door)	2200

② Extension 70x70 mm, Black RAL 9011

E3301-110	1100
E3301-220	2200

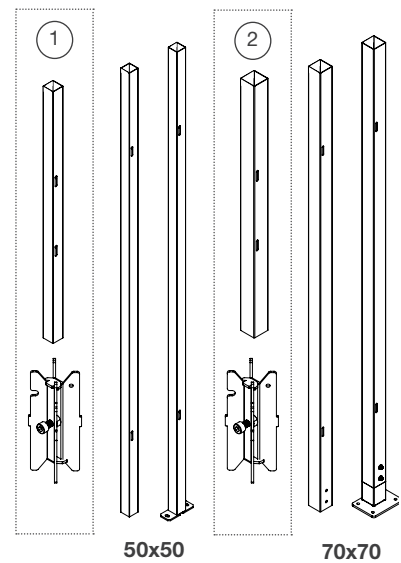

50x50

70x70

Suitable doors for X-Store 2.0 » Without ceiling

Example of doors suitable to X-Store system without ceiling						
Door	Art.No.	Height cage/door 2300/2300 mm	Height cage/door 3400/2300 mm	Height cage/door 3400/3400 mm*	Height cage/door 4500/2300 mm	Height cage/door 4500/4500 mm*
①	D10-XXX150	✓		3 widths**		✓
①	D11-XXX150	✓	✓	3 widths**	✓	✓
②	D12-230300	✓				
③	D20-XXX100	✓	✓	✓	✓	✓
③	D20-XXX140	✓	✓	✓	✓	✓
③	D20-XXX220	✓	✓	✓	✓	✓
③	D20-XXX310	✓	✓	✓	✓	✓
③	D20-XXX570	✓	✓	✓	✓	✓
④	D22-XXX290	✓	✓	✓	✓	✓
④	D22-XXX590	✓	✓	✓	✓	✓
⑤	D23-XXX300	✓				
⑥	D23-XXX450	✓				
⑦	D24-230140, -230290	✓				
①	D30-XXX150	✓	✓***	3 widths**	✓***	✓
②	D32-230300	✓				
③	D40-XXX100	✓	✓	✓	✓	✓
③	D40-XXX140	✓	✓	✓	✓	✓
③	D40-XXX220	✓	✓	✓	✓	✓
③	D40-XXX310	✓	✓	✓	✓	✓
③	D42-XXX570	✓	✓	✓	✓	✓
④	D42-XXX290	✓	✓	✓	✓	✓
④	D42-XXX590	✓	✓	✓	✓	✓
⑤	D43-XXX300	✓				
⑥	D43-XXX450	✓				
⑦	D44-230140, -230290	✓				

* Article number ends with -B

** Only door panels in the widths 800 mm, 1000 mm & 1500 mm are selectable

*** Replaced by D11-XXX150

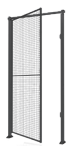

①

Single hinge door



②

Double hinge door



③

Single sliding door

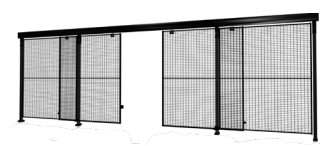

④

Sliding door with centre lock



⑤

Double sliding door
with 2-step rail

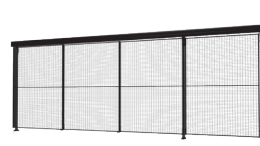

⑥

Triple sliding door
with 3-step rail



⑦

Double sliding door,
overlapping

Suitable doors for X-Store 2.0 » With ceiling

Example of doors suitable to X-Store system with ceiling						
Door	Art.No.	Height cage/door 2300/2300 mm	Height cage/door 3400/2300 mm	Height cage/door 3400/3400 mm*	Height cage/door 4500/2300 mm	Height cage/door 4500/4500 mm*
①	D10-XXX150					
①	D11-XXX150	✓	✓	3 widths**	✓	✓
②	D12-230300	✓				
③	D20-XXX100		✓		✓	
③	D20-XXX140		✓		✓	
③	D20-XXX220		✓		✓	
③	D20-XXX310	✓	✓	✓	✓	✓
③	D20-XXX570					
④	D22-XXX290	✓	✓	✓	✓	✓
④	D22-XXX590	✓	✓	✓	✓	✓
⑤	D23-XXX300	✓				
⑥	D23-XXX450					
⑦	D24-230140, -230290	✓				
①	D30-XXX150***	✓	✓	3 widths**	✓	✓
②	D32-230300	✓				
③	D40-XXX100	✓	✓	✓	✓	✓
③	D40-XXX140	✓	✓	✓	✓	✓
③	D40-XXX220	✓	✓	✓	✓	✓
③	D40-XXX310	✓	✓	✓	✓	✓
③	D42-XXX570					
④	D42-XXX290	✓	✓	✓	✓	✓
④	D42-XXX590	✓	✓	✓	✓	✓
⑤	D43-XXX300	✓				
⑥	D43-XXX450	✓				
⑦	D44-230140,-230290	✓				

* Article number ends with -B

** Only door panels in the widths 800 mm, 1000 mm & 1500 mm are selectable

*** Replaced by D11-XXX150

Wide range of doors

The wide range of locks and doors for the X-Store system are based on the same range as for Axelent X-Guard. Have a look at the guide above to see examples of which doors that are suitable for your desired X-Store system. For the complete selection of doors, see axelent.com » X-Store

The X-Store door package gives you easy and secure access to the enclosure.



When drawing your project in SnapperWorks the program automatically picks matching doors.

Curious about SnapperWorks? The program is developed by Axelent and completely free of charge. Contact your local sales office for more information.
» www.axelent.com

Product Facts » X-Store 2.0

Accessories

Art.no.	Width (mm)	Height (mm)
---------	------------	-------------

① Adjustable infill, Light grey RAL 9018

T07-4-11031	317	1100
T07-4-22031	317	2200

② Golvfot, Svart RAL 9011

P3101-082	100	825
-----------	-----	-----

①



②



③ Corner brackets 90°, 3 pcs

95001

Cutting package, Light grey RAL 9018

KHX-4-150	Horizontal	
KVX-4-110	Vertically	1100
KVX-4-220	Vertically	2200

③

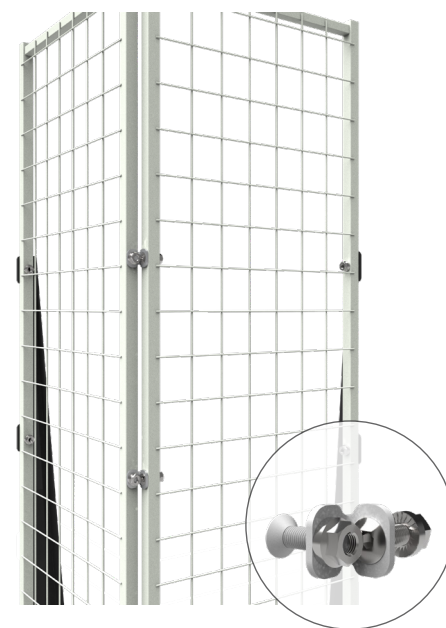

④ Hinge, 0-90°, 2 pcs (bolt/bolt)

B10-3B

④

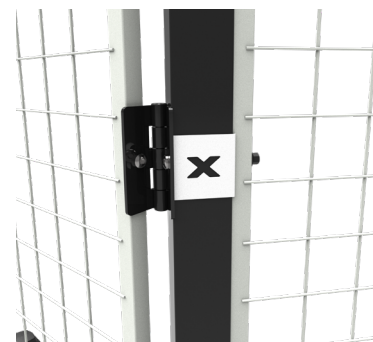

Product Facts » X-Store 2.0

Locks	
Kind	Description
① X-It	
XIT-L01-101	Cylinderlock X-It compl, left mech, hinge door, X-Guard
XIT-L01-301	Cylinderlock X-It compl, left mech, single sliding door, X-Guard
XIT-L01-401	Cylinderlock X-It, left mech, slidingdoor with centrelock, X-Guard
XIT-L02-101	Cylinderlock X-It compl, left mech + panic, hinge door, X-Guard
XIT-R01-101	Cylinder lock X-It compl, right mech, hinge door, X-Guard
XIT-R01-301	Cylinder lock X-It compl, right mech, single sliding door, X-Guard
XIT-R01-401	Cylinderlock X-It, right mech,slidingdoor with centrelock, X-Guard
XIT-R02-101	Cylinderlock X-It compl, right mech + panic, hinge door, X-Guard
XIT-L02-301	Cylinderlock X-It compl, left mech + panic, sliding door, X-Guard
XIT-L02-401	Cylinderlock X-It compl, left mech + panic, sliding door center lock, X-Guard
XIT-R02-301	Cylinderlock X-It compl, right mech + panic, sliding door, X-Guard
XIT-R02-401	Cylinderlock X-It compl, right mech + panic, sliding door center lock, X-Guard
② Padlock brackets	
L10-00-0	Padlock brackets for hinge door, right/left
L20-00-0	Padlock brackets for sliding door, right/left
L22-00-0	Padlock brackets for sliding door with centre lock
③ Bail handle	
T01-22	Bail handle c/c 150mm, set of 2 incl. mounting plates
④ Snap lock	
L10-05-0	Snap lock for hinge door, right/left
L20-05-0	Snap lock for sliding door, right/left
L22-05-0	Snap lock for sliding door with centre lock

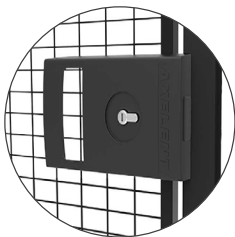

① X-It

Axelent X-It is a patent-pending, ingenious cylinder lock with a unique design that requires no extra case.

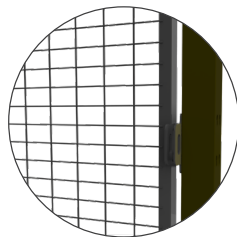

② Padlock brackets

Our most simple lock system. A normal hinge lock secure the area from being entered by unauthorized.

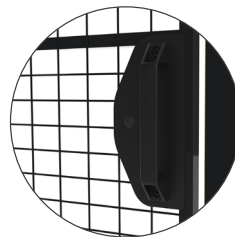

③ Bail handle

The shackle handle is supplied as a set of 2 pieces and an attachment.

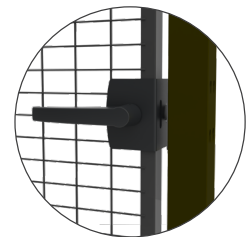

④ Snap lock

The door closes with a simple push and is kept closed by the built-in catch.



AXELENT · AXELENT ENGINEERING · AXELENT SOFTWARE · AXELENT SAFE-X

AXELENT AB · BOX 1 · KÄVSJÖVÄGEN 17 · 335 04 HILLERSTORP, SWEDEN
0370-37 37 30 · SALES@AXELENT.SE · WWW.AXELENT.SE



GB2004_1.0 SAKA